





Interactive Intelligent Panel Display

Owner's Operating Manual



Before operating the unit, please read this manual thoroughly, and retain it for future reference.

Contents

Security Warning	1
Prepare to Install	2
Connection and Setting	8
Menu Operation	13
Simple troubleshooting	24
Maintenance	25
Display Mode	25

Security Warning

Before using the machine, please read the instructions carefully, and keep well after reading for future review.

Placement

- Do not put the machine on places that are unstable, easy to tilt and fall.
- Do not put the machine on places with direct sunlight, or places near hot objects such as electric heater or other sources of heat and strong light source.
- Do not use the machine beside equipments of strong radiation.
- Do not put the machine in damp places or places with liquid drops and splash.
- Do not insert any item to inside of machine.
- Do not place heavy objects on the machine.

Power Supply

- Please check and make sure compatibility between the voltage value on back shell nameplate and the main power supply voltage value.
- In case of thunderstorm and lightning weather, please unplug power cord and antenna plug.
- When no one is indoor or not in use for a long time, please unplug the plug.
- Please prevent power cord from physical or mechanical damage.
- Please use special power cord, and do not modify and extend power cord.
- Please check and make sure the AC power ground wire is connected.

Screen

- When writing in screen, please do not use hard or sharp objects instead of writing pen.
- When it needs cleaning, please unplug the power plug first.
- Please use soft dust-free dry cloth to wipe the screen.
- Do not use water and spray cleaner to clean the machine.
- Please contact service center for cleaning of internal machine.
- Do not display image with high brightness on the screen for a long time.

Range of Visibility

- The best distance between eyes of viewer and listener and screen is 5 to 7 times of screen diagonal.
- The best viewing angle between eyes of viewer and listener and screen is within 176 degrees up and down, left and right.

Temperature

- Do not place the machine near the electric radiator or heating unit.
- When moving the machine from low temperature area to high temperature area, in order to make internal condensation sufficiently diffusing, please place for a period of time and then connect electricity to turn on.
- Machine's normal working temperature is 0 ~ 40°C, storage temperature is -20~60°C

Humidity

- Do not expose the machine in the rain, wet, or places near the water.
- Please make sure indoor dry and cool, machine normal working humidity is 10~90%, storage humidity is 10~95%.

Ventilation

- Please put the machine in ventilated places, and ensure machine's good heat dissipation.
- Make sure ventilation of spaces 10 cm on the left, right side and back , 20 cm on the top.

Headphones

- Using headphones for a long time to listen noisy sound is easy to influence auditory.
- If external earphone is needed, please turn down machine volume in advance.

Standby

- The standby button on the front of machine body will not completely shut off the machine, but only allows the machine in standby status.

Battery

- Waste batteries after used in the machine needs to be properly disposed and recycled.
- Please do not let children touch the battery, do not put battery into water, to avoid risks.

Statement

- This product is Level 4 product, and in the living environment, this product may cause radio interference. In this case, the user may be required to take practical measures to its interference.

Prepare to Install

1 Unpackaging

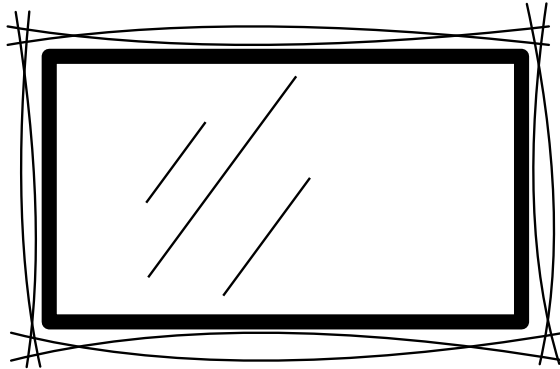

1) Accessories:

Quick start guide, remote control, power cord, VGA cable, headphone line, USB line, writing pen, DVD, AV line



Quick Start Guide

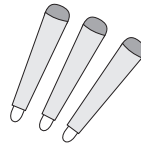

Writing pen



Remote control

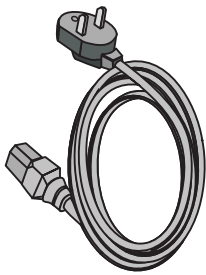

Power Cord



VGA Cable

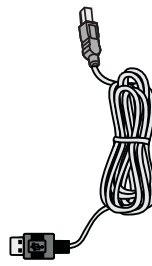

USB Cable

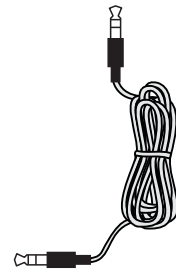

Headphone Cable



AV Cable



DVD





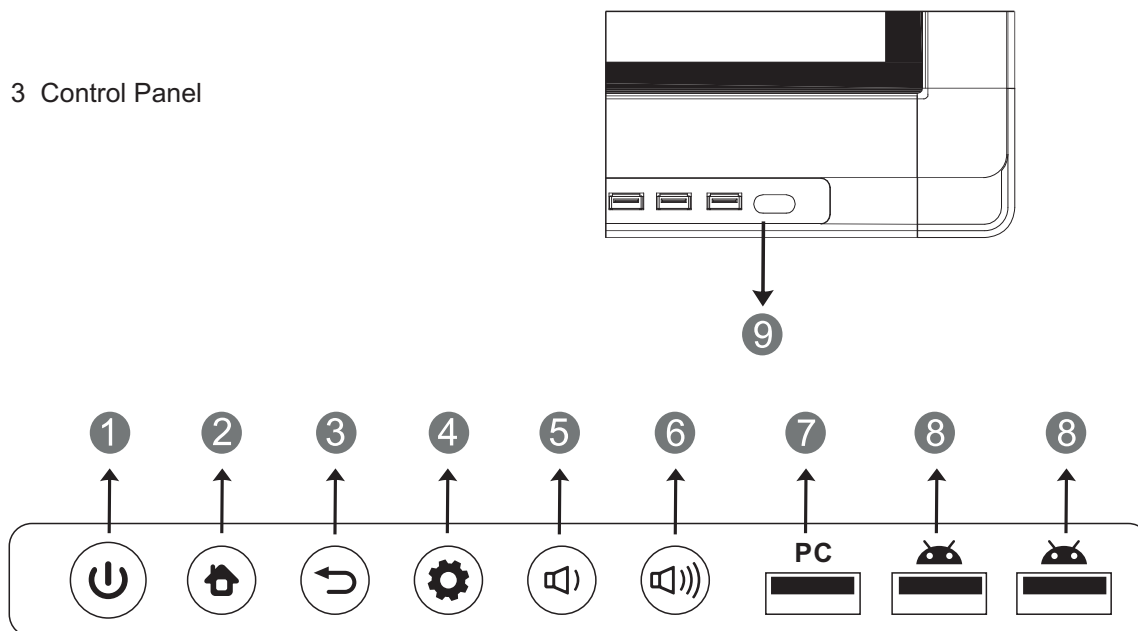

- 2).Foot stool (optional) shall be subject to actual article.
- 3).Wall hanging (optional) shall be subject to actual article.

2、 Installation

- 1).See Foot Stool Installation Instruction for installation of foot stool.
- 2).See Wall Hanging Installation Instruction for installation of wall hanging.







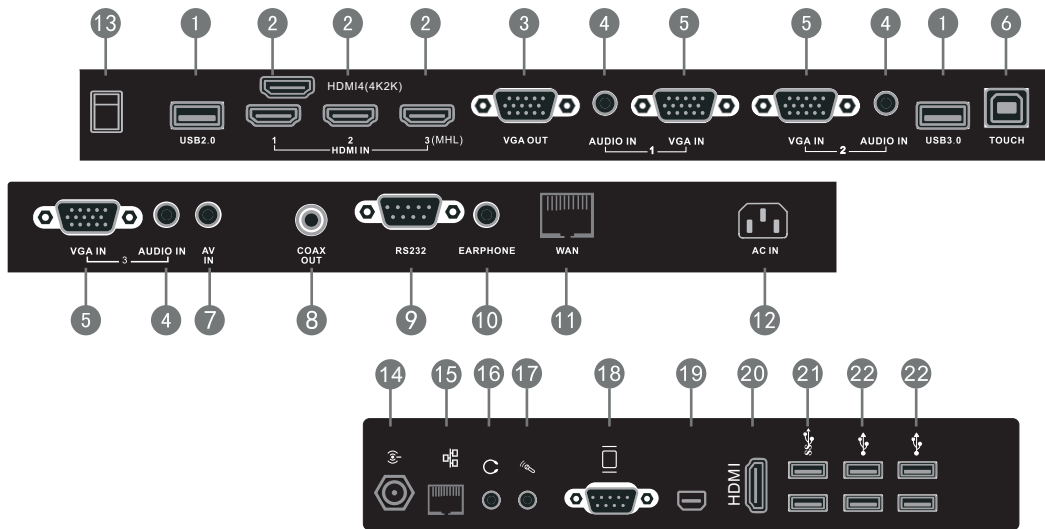

3 Control Panel



Items	Function description
① 	Tap to enter EnergySaving function Press at least 2 seconds to enter standby mode
② 	HOME button: back to main interface
③ 	Return button: return to previous level menu
④ 	Menu button: call up function menu
⑤ 	Volume down button: turn down volume
⑥ 	Volume up button: turn up volume
⑦ PC	Built-in computer USB interface, see Point 6 on page 11 for details
⑧ 	USB interface of Android system, which can access storage device to play media files
⑨ Remote control signal receiver	Receiving remote control signal, and do not place any objects to block remote control receiving

3 Terminal Interface



Items	Function description
① USB	Connect USB devices such as mobile hard disk, U disk, USB keyboard and mouse, USB drives, etc
② HDMI IN	High-definition multimedia interface signal input, connect to PC (personal computer) with HDMI output, set-top box, or other video device can also realize touch function (HDMI3 can realize MHL function, HDMI4 can realize 4K*2K)
③ VGA OUT	Connected to display devices with VGA input function
④ AUDIO IN	External computer audio input
⑤ VGA IN	External computer image input
⑥ TOUCH	External computer touch signal input. Default touch function is available under internal computer, when connecting external computer, besides connecting external computer VGA and audio signals, external computer's USB port needs to be connected to the equipment. Under the condition that driver is installed, external computer can be touch controlled through the equipment (touch function is effective in PC, VGA and HDMI channel by default)
⑦ AV IN	Composite video and audio input
⑧ COAX OUT	Coaxial output
⑨ RS232	Serial interface, used for mutual transfer of data between devices
⑩ EARPHONE	Connected to device with headphone input function
⑪ WAN	WAN interface, connecting RJ45 terminals. (This network port is only used for Android system)
⑫ AC IN	AC power input, connecting AC power supply
⑬ POWER SWITCH	Power switch, to open and shut down AC power supply "I" is ON, "O" is OFF.
⑭ 	WIFI antenna interface
⑮ 	Network interface, connecting RJ45 port to connect to the Internet. (This network port is only used for PC)
⑯ 	Connected to device with headphone input function
⑰ 	Connect to device with microphone voice collection (used for recording function)
⑱ 	Connected to display device with VGA input function
⑲ 	Connected to device with DisplayPort input function
⑳ HDMI	Connected to device with HDMI input function
㉑ 	USB 3.0 interface to connect USB devices, such as mobile hard disk, U disk, USB keyboard and mouse, USB drives, etc
㉒ 	USB 2.0 interface to connect USB devices, such as mobile hard disk, U disk, USB keyboard and mouse, USB drives, etc







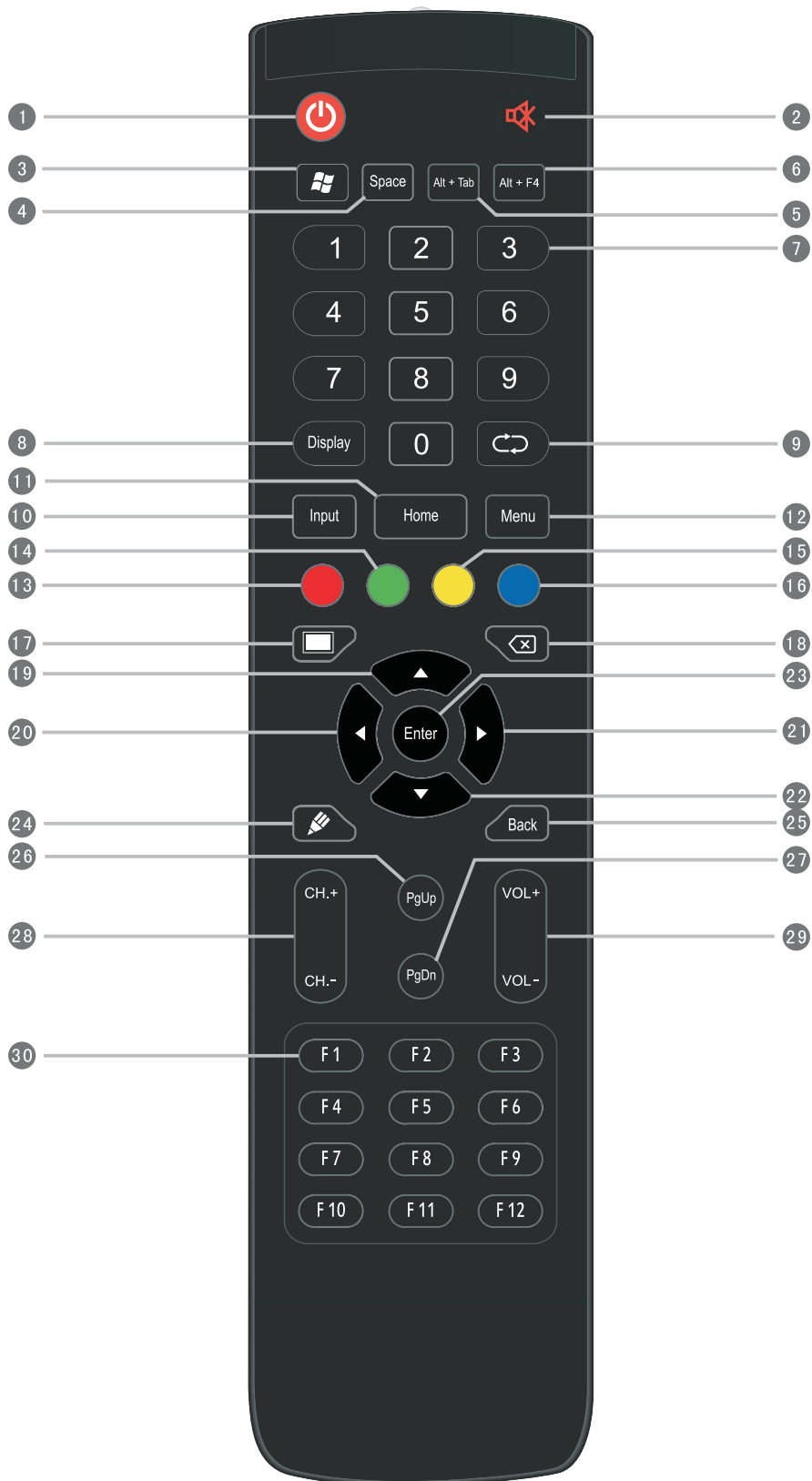



NOTE: In case of no built-in computer, it does not includes interface 14,15,16,17,18,19,20,21and 22.

5 Remote control

1). Remote control button instruction



Detailed function description of remote control buttons

- 1  : Press this button to enter standby when power is on; Click this button to switch on in standby condition
- 2  : Mute switch
- 3  : Built-in computer Windows key
- 4 Space : Built-in computer Space key
- 5 Alt+Tab : Built-in computer spacebar Alt + Tab
- 6 Alt+F4 : Built-in computer program window close button
- 7 Numeric keys : TV digital channels input keys
- 8 Display : Display channel information
- 9  : TV channel return key
- 10 Input : Input signal source selection key, choose different sourced according to need
- 11 Home : Android system main screen button
- 12 Menu : TV OSD menu button, press this button to pop up TV's OSD menu
- 13 Red : TV channel function button
- 14 Green : TV channel function button
- 15 Yellow : TV channel function button
- 16 Blue : TV channel function button
- 17  : One key for blank screen
- 18  : Backspace key
- 19  : Direction key, press this button for upwards selection
- 20  : Direction key, press this button for left selection
- 21  : Direction key, press this button for right selection
- 22  : Direction key, press this button for downwards selection
- 23 Enter : confirmation key, press this key to confirm selection state
- 24  : Quickly start writing software, select writing pen quickly if software is started.
- 25 Back : Return key
- 26 PgUp : Built-in computer page (previous page)
- 27 PgDn : Built-in computer page (next page)
- 28 CH. +, CH. - : Channel switch key
- 29 VOL+, VOL- : Volume switch key
- 30 F1-F12 : Built-in computer F1 - F12 function keys

NOTE: In case of no built-in computer, all function keys related with computer are regarded as no operating functions

2).Remote control use instructions

Install Batteries

- 1 Open back cover of battery component on the back of remote control
- 2 Install AAA type battery according to the corresponding electrode, make sure battery positive and negative pole are correct ("+"to"+"", "-" to "-"), please do not mix using old and new batteries
- 3 After battery is installed, close the back cover of battery components, and make the following clip buckled to the bottom

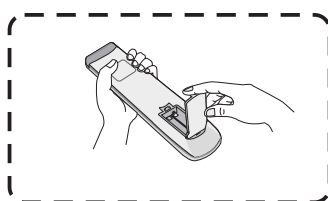

(1)

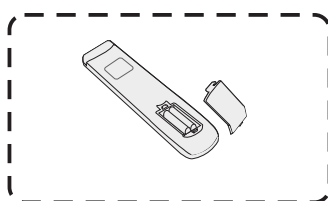

(2)

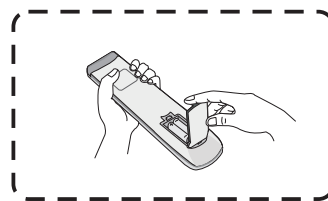

(3)

Range of remote control

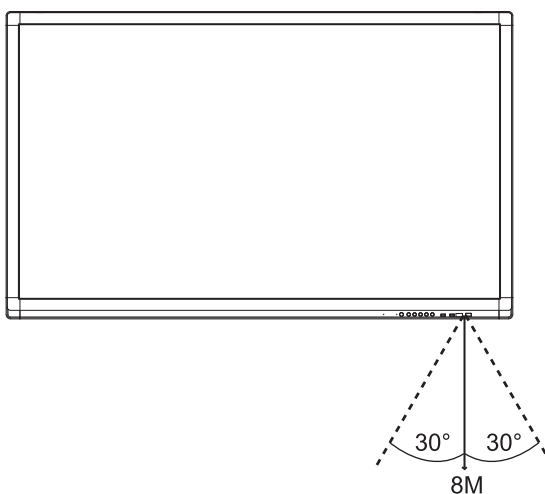

Remote control can work normally within the range of 8 meters distance, 30 degrees left and right from the remote control receiver; in order to protect environment, please dispose waste battery into recycling box.

CAUTION
 RISK OF EXPLOSION IF BATTERY IS REPLACED
 BY AN INCORRECT TYPE
 DISPOSE OF USED BATTERIES ACCORDING
 TO THE INSTRUCTIONS

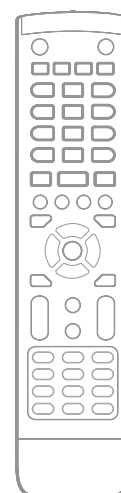

Connection and Setting

 For the safety of you and the machine, please do not connect any power plug before

1. External Computer and Touch Connection

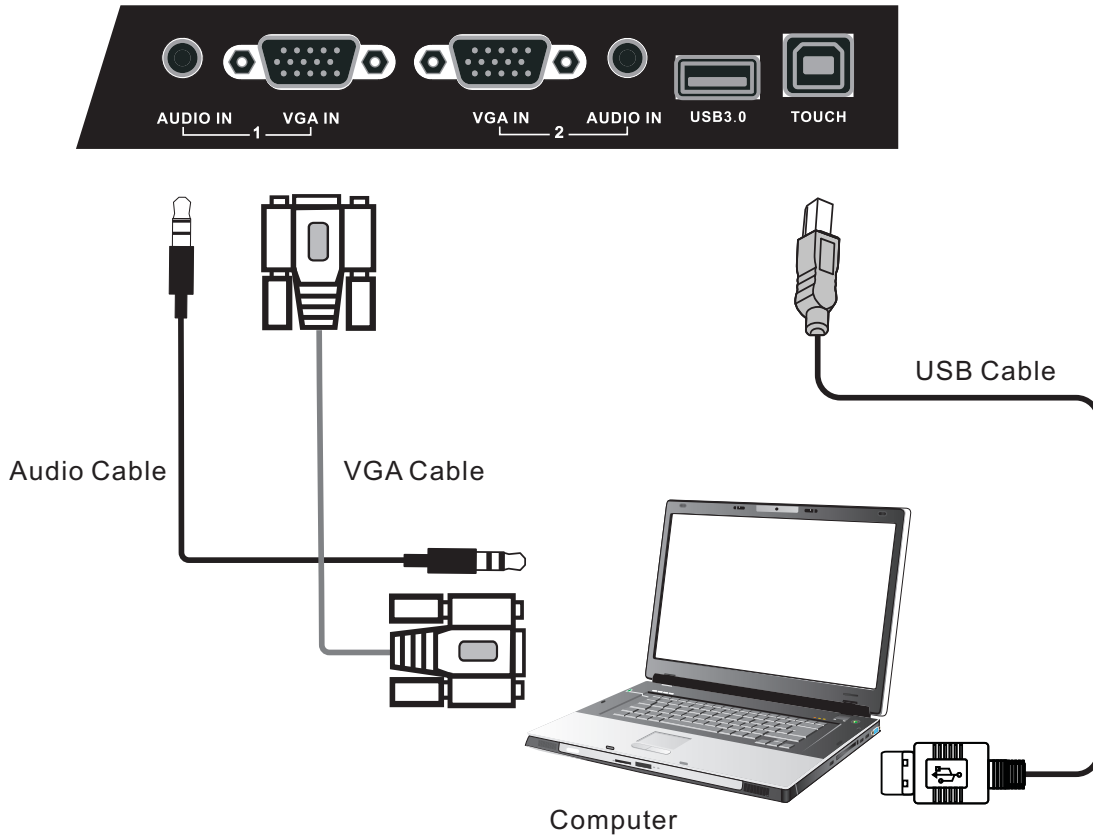

- (1) Use VGA line to connect to VGA output port of external computer, and meanwhile use headphone audio line to connect to external computer audio output interface.
- (2) Use USB line to connect to external computer USB port.
- (3) After connection is completed, plug in power cord, and switch POWER to On.
- (4) Start external computer.
- (5) Press  key, and the equipment is powered on.
- (6) Press the INPUT key to switch to VGA channel.



NOTE:

External computer input, equipment's best resolution is 1920 x1080

External computer can also connect to the equipment through the HDMI cable

• Recommended computer configuration:

2.0GBHZ Processor, 1GB Memory

More than 256 color display card

1GB Available Hard Drive

Support Resolution 800*600,1024*768

VGA-OUT/HDMI-OUT、Audio-OUT、USB Interface

2. Audio and video equipment

1) .AV

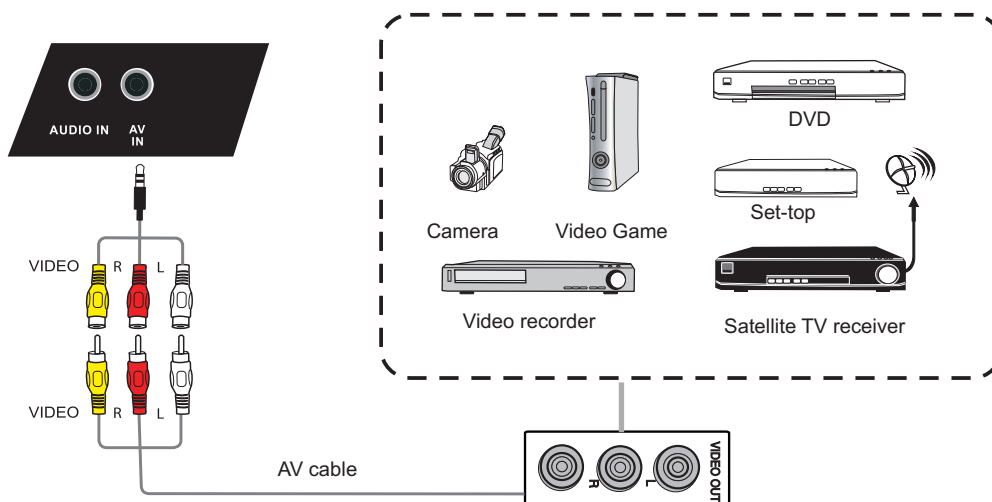

- (1).Use AV audio and video lines to connect audio and video equipments with AV output (yellow for video, red for right sound channel, and white for left sound channel)
- (2).After line connection, plug in power cord, and switch power On
- (3).Press  to turn equipment on
- (4).Press INPUT key to switch to CVBS port

2) .HDMI 1/HDMI2/HDMI3 (MHL)/HDM4(4K2K)

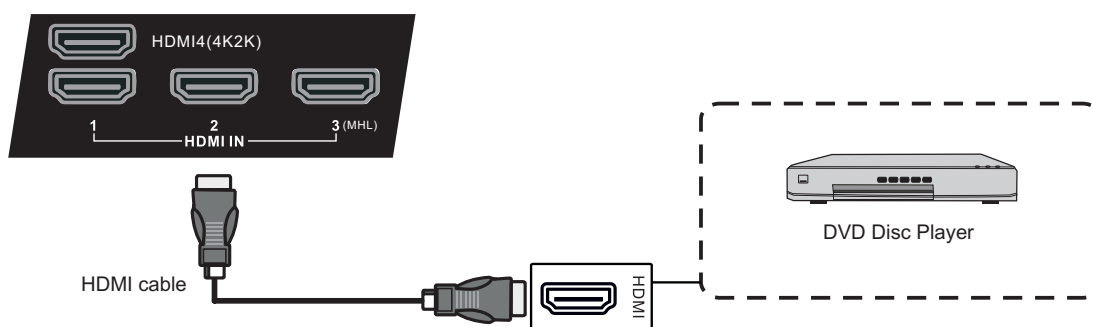

- (1).Use HDMI line to connect audio and video equipment with HDMI output
- (2).After line connection, plug in power cord, and switch power On
- (3).Press  to turn equipment on
- (4).Press INPUT key to switch to HDMI port (HDMI3 channel can realize MHL function,HDMI4 channel can realize 4K*2K)

3. Coaxial connection

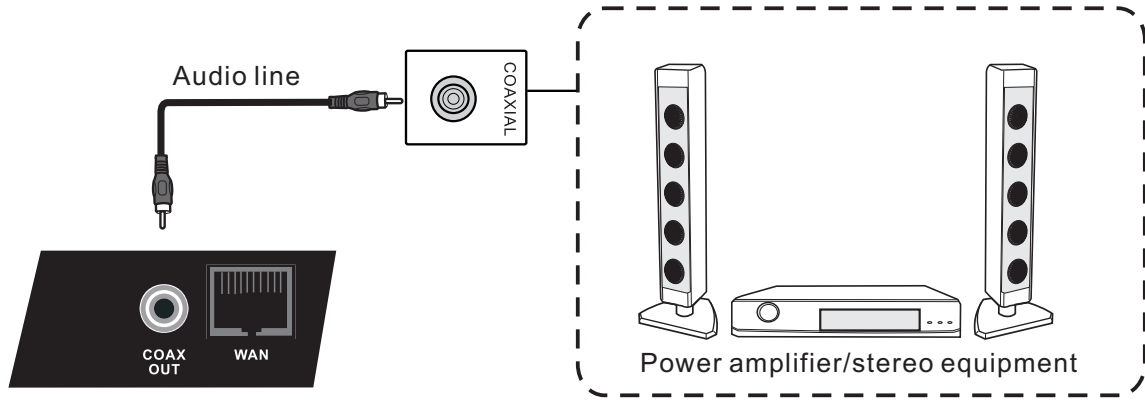

- (1). Use coaxial line to connect audio device with coaxial input
- (2). After line connection, plug in power cord, and switch power On
- (3). Press  to turn equipment on

4. Video output connection

1). VGA output connection

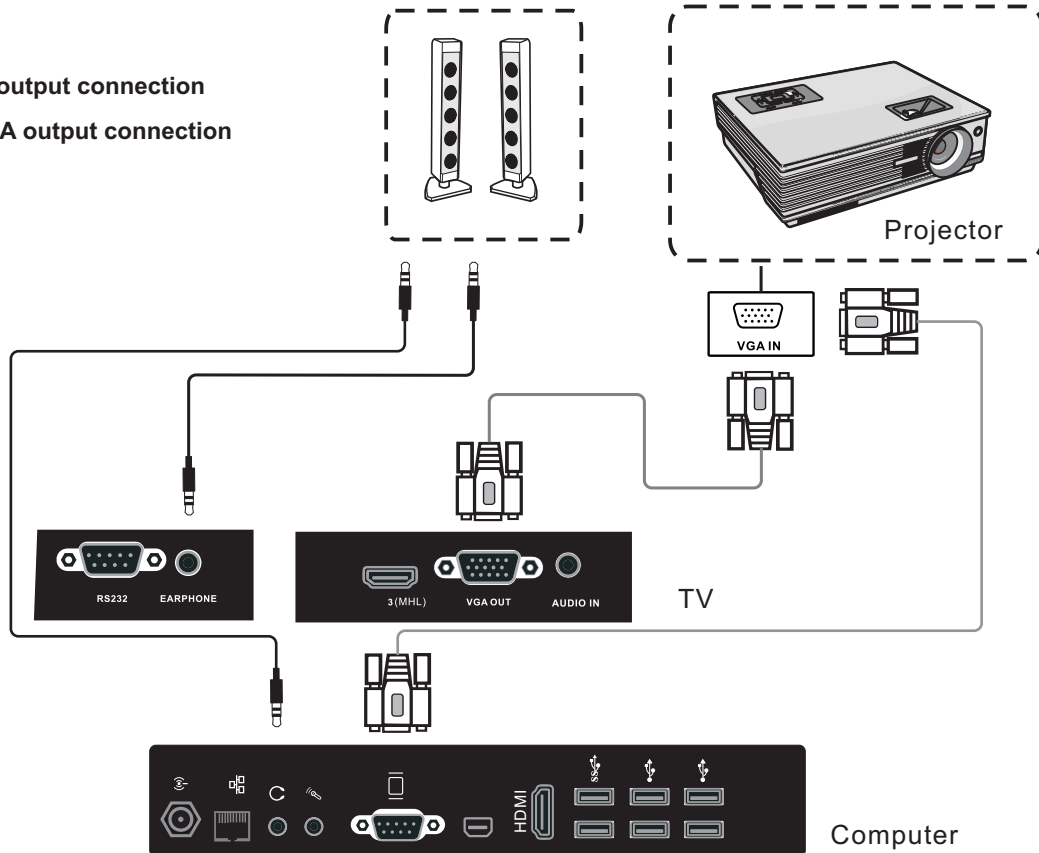

Computer

- (1). Use VGA line to connect display devices with VGA input, and use headphone line to connect sound output
- (2). After line connection, plug in power cord, and switch power On
- (3). Press  to turn equipment on
- (4). Press INPUT key to switch to PC port
- (5). Set internal computer as VGA output or multi-screen display

TV

Note: VGA OUT of TV outputs VGA IN graphics and sound

5. USB Equipment connection

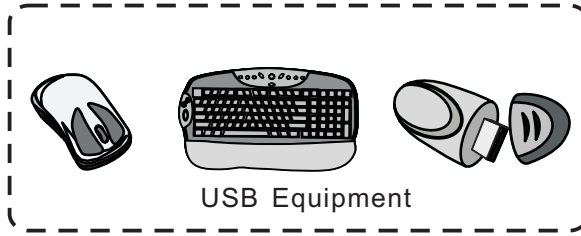

6. Network cable connection

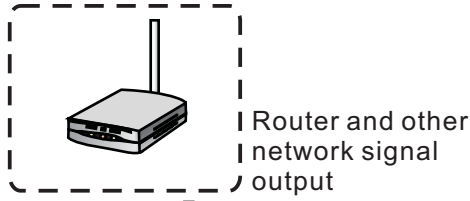

7. Microphone connection

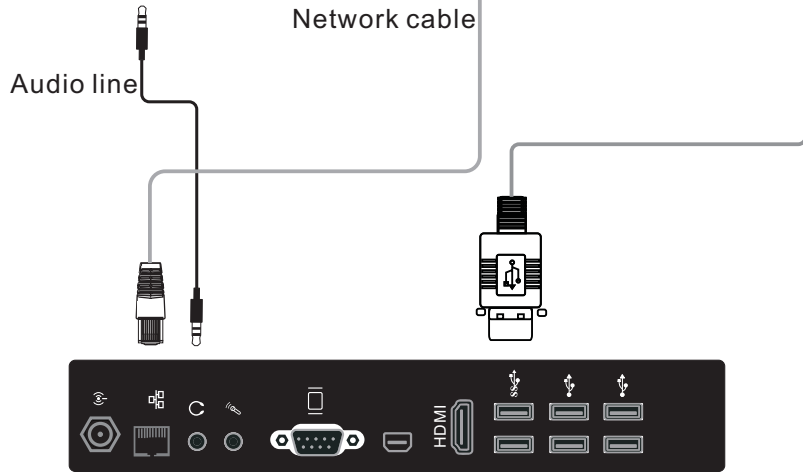

8. WAN Connection

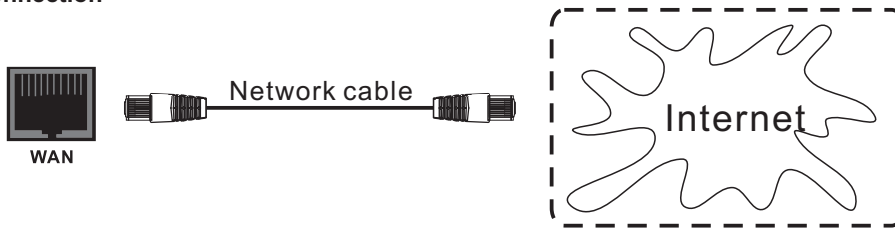

NOTE: If the user want the built-in computer and android system connect to the Internet at the same time, Connect item 6 and item 8 at the same time.

11. USB Equipment connection

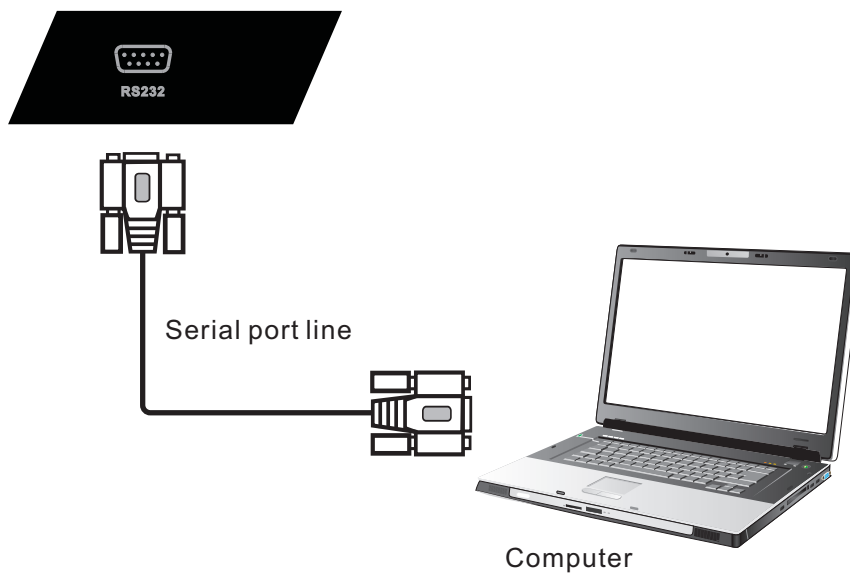

After using serial port line to connect central control equipment and machine, certain function of the machine can be controlled via central control equipment, such as: machine ON/off, and adjustment of sound volume, etc

PC part basic operations :

1. In case that TV is on and the computer is not started, press INPUT key to switch from channels other than PC to PC channel, then turn on the computer.
2. When it is on, hold down POWER key for 2 seconds, click to select "Confirm" in the pop-up reminder menu to close TV and computer together.
3. Under PC channel when it is on, touch to select "WINDOWS" button on the lower left of desktop or press "WINDOWS" key on remote control, and then select "power off" item, to turn off computer when not turning off TV.

Menu Operation

One Touch menu operation

Call up method

Take middle point position on the bottom of display screen as starting point, use touch pen to drag towards screen center position to call up touch menu, as shown below.

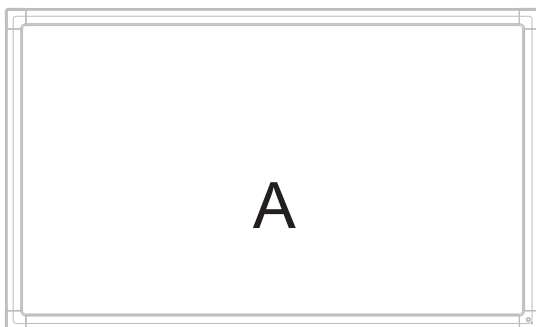

Setting menu

Input setting

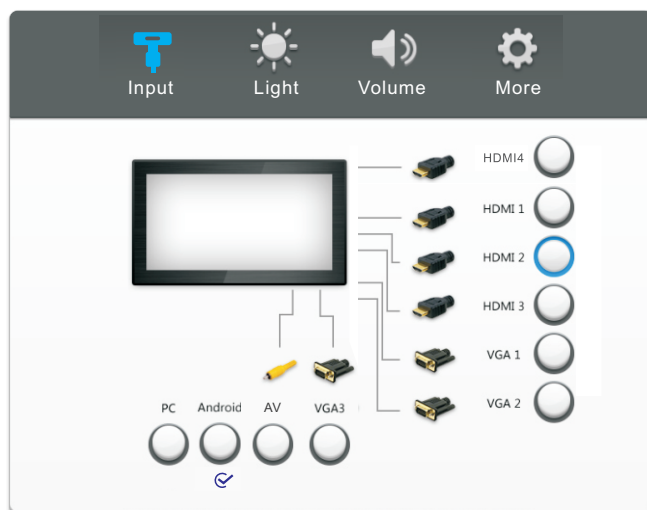

- Press INPUT button on remote control or via touch A method to call up Input Setting menu;
- Press ▼/▲/◀/▶ button on remote control to select the channel you need;
- Press the Enter button on remote control or directly click with touch pen to confirm selected input channel;
- Press return key on remote control, or click blank area outside menu with touch pen to exit menu.

Note: “ ✓ ”symbol represents that this channel has been connected to a signal

Brightness Setting

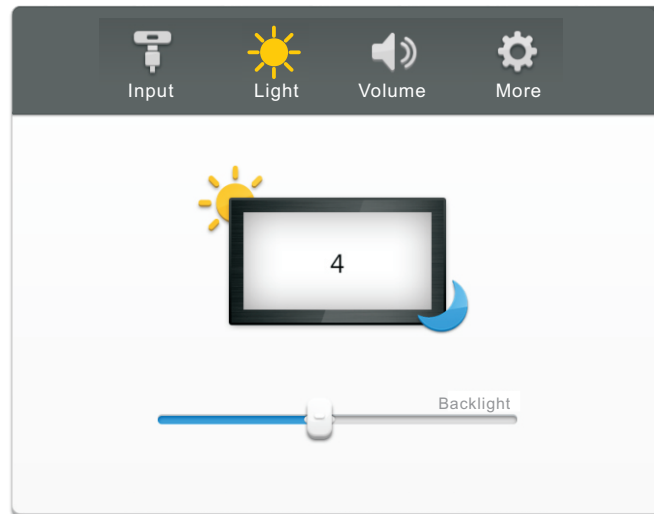

- Press INPUT button on remote control or via touch A method to call up Input Setting menu;
- Press ► button on remote control or directly click "Light" icon with touch pen to enter Brightness Setting menu;
- Press ◀/▶ button on remote control or drag brightness adjustment progress bar with touch pen to adjust brightness;
- Press return key on remote control, or click blank area outside menu with touch pen to exit menu.

Menu Operation

Volume setting

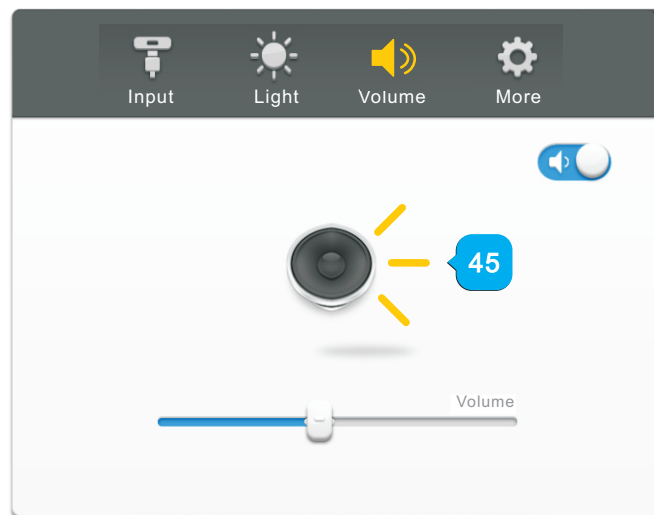

- Press INPUT button on remote control or via touch A method to call up Input Setting menu;
- Press ► button on remote control or directly click "Volume" icon with touch pen to enter Volume Setting menu;
- Press ◀/▶ button on remote control or directly drag volume adjustment progress bar with touch pen to adjust volume;
- Press < Mute > button on remote control or directly click mute icon below "More Settings" with touching pen to open or close mute state;
- Press return key on remote control, or click blank area outside menu with touch pen to exit menu.

More Settings (advanced setting)

1. Android channel

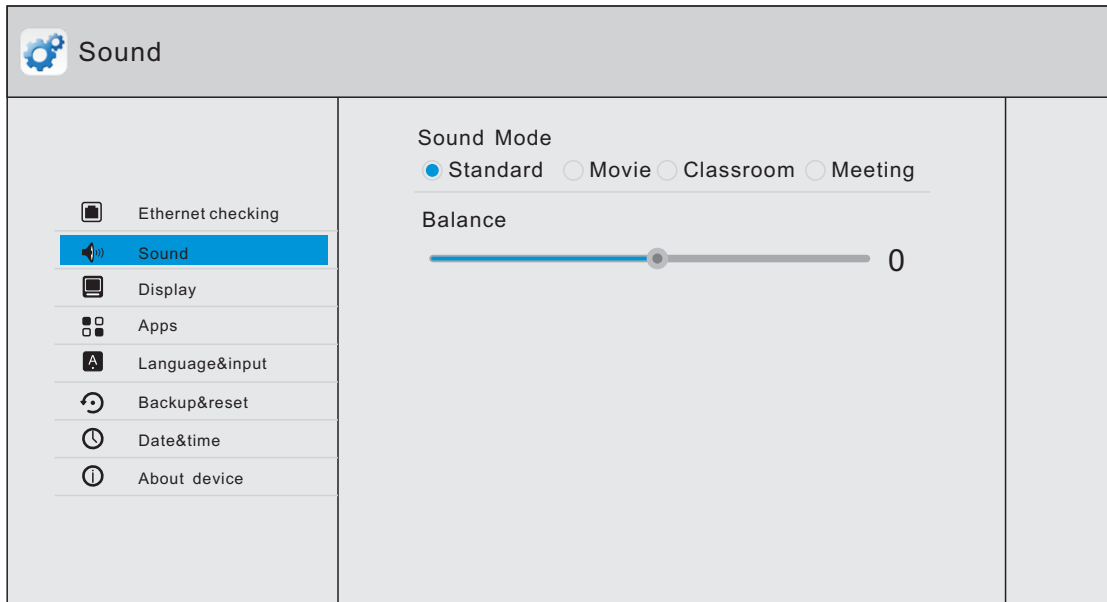

- Under Android channel, press INPUT button on remote control or via touch A method to call up Setting menu;
- Press ► button on remote control or directly click “More”icon with touch pen to enter advanced setting menu
- Press ▼/▲/◀/▶ button on remote control or click directly with touch pen to select each option;
- Press return key on remote control or front panel of equipment to exit menu.

Ethernet checking

View the current network connection status and the network parameters of the device .

Sound

Adjust the volume of equipment (standard model/music mode).

Dispaly

Adjust equipment display brightness/system wallpaper and system font size.

Apps

Display each application in Android system memory.

Language&input

Adjust display language and input method settings of Android system.

Backup&reset

Under Android system, restore factory settings/repair system or restore system.

Date&time

Under Android system, set system time and format (time can be automatically obtained or manually set).

About device

Display Android system software version information.

2. VGA Channel

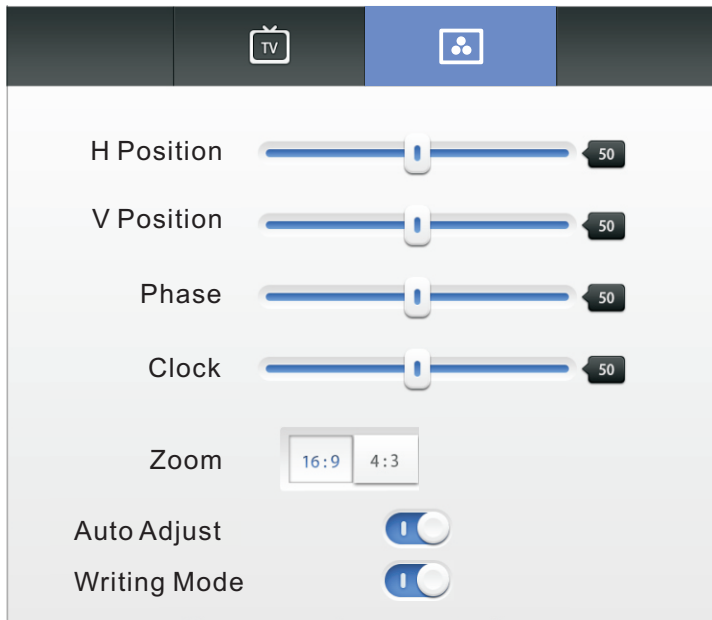

- Under VGA channel, press INPUT button on remote control or via touch A method to call up setting menu;
- Press ► button on remote control under setting menu or directly click “More” icon with touch pen or directly press Menu on remote control under VGA channel to enter advanced setting menu;
- Press ▼/▲/◀/▶ button on remote control or click directly with touch pen to select and adjust each option;
- Press return key on remote control, or click blank area outside menu with touch pen to exit menu.

H position

Press ◀/▶ button on remote control or directly drag icon with touch pen to adjust horizontal position of image;

V Position

Press ◀/▶ button on remote control or directly drag icon with touch pen to adjust vertical position of image;

Phase

Press ◀/▶ button on remote control or directly drag icon with touch pen to adjust phase position of image;

Clock

Press ◀/▶ button on remote control or directly drag icon with touch pen to adjust clock of image;

Zoom

Press ◀/▶ button on remote control or press Enter button or directly click icon with touch pen to switch image display ratio;

Auto Adjust

Press ◀/▶ button on remote control or directly click icon with touch pen to automatically adjust horizontal, vertical position/ phase and clock of image;

Writing Mode

Press ◀/▶ button to on/off the writing mode.

3. Screen Setting

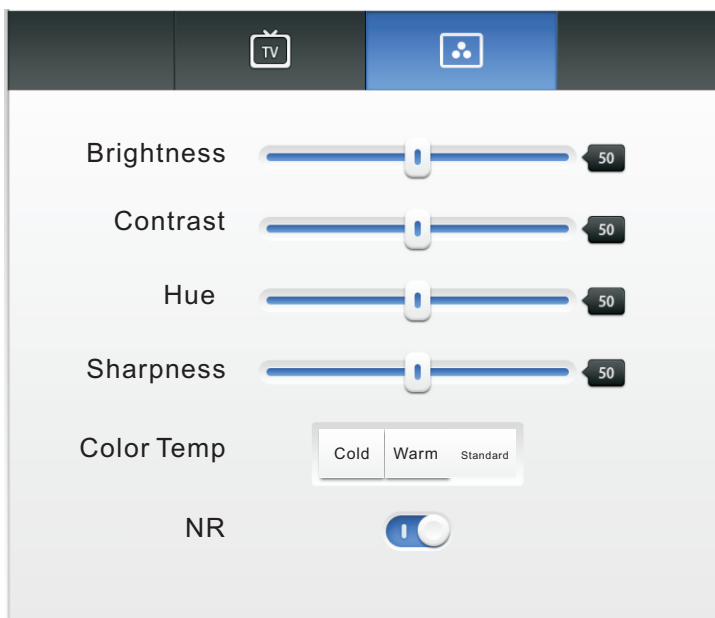

- Under channels other than Android, press Menu button on remote control or via touch A method to call up setting menu;
- Press ► button on remote control or directly click “More” icon with touch pen or directly press Menu on remote control to enter advanced setting menu;
- Press ▼/▲/◀/▶ button on remote control or click directly with touch pen to select and adjust each option;
- Press return key on remote control, or click blank area outside menu with touch pen to exit menu.

Brightness

Press ◀/▶ button on remote control or directly drag icon with touch pen to adjust brightness of image.

Contrast

Press ◀/▶ button on remote control or directly drag icon with touch pen to adjust contrast of image.

Hue

Press ◀/▶ button on remote control or directly drag icon with touch pen to adjust tone of image.

Sharpness

Press ◀/▶ button on remote control or directly drag icon with touch pen to adjust sharpness of image.

Color Temp

Press ◀/▶ button on remote control or directly drag icon with touch pen to adjust color temperature of image (Cool color/warm color/automatic).

NR







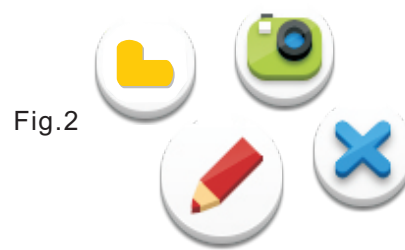

Press ◀/▶ button on remote control or directly drag icon with touch pen to open or turn off noise reduction function.

Note: different options in different channels can't be adjusted, please select according to actual situation.

4. Annotation menu



- Place two fingers on the screen (about 20~50mm spacing) and stay more than two seconds under any channel to call up annotation menu (Figure 1);
- In annotation, menu is shown in Figure 2.
- In annotation state, input only by touch pen, and remote control cannot perform notation operation.

	Annotation menu icon	Pop up sub-menu
	Return icon	Click to return to previous operation interface
	Main interface icon	Click to return to main interface of Android system
	Annotation brush icon	Click to make annotation in the picture, click again to change brush color
	Whiteboard icon	Click to enter Whiteboard software Screen image will be saved automatically when exiting Whiteboard software. Storage location: resource browse/blackboard writing
	Resource browse icon	Click to open resources browse menu
	Screenshot icon	Click for screenshot of current annotation image Screenshot storage location: resource browse/blackboard writing
	Close icon	Click to close annotation menu

Two Android System Interface

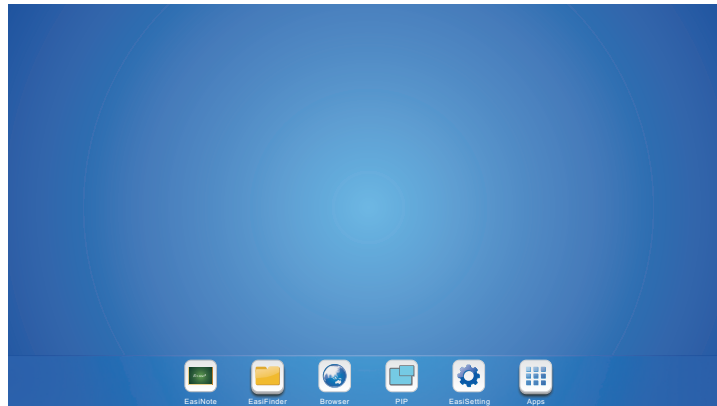

Main Interface





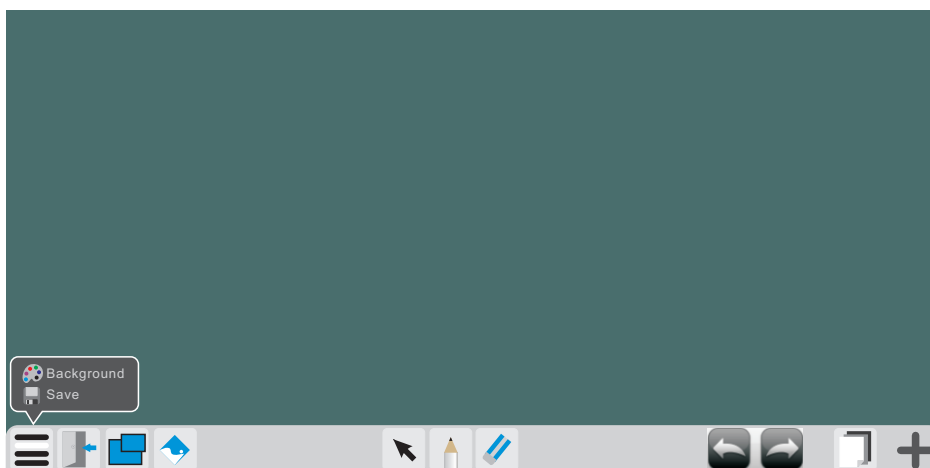





- Switch to Android channel to display main interface as show above;
- Press ◀/▶ key on remote control to select icon below, and press Enter key to enter corresponding program, or directly click icon with touching pen to enter program;
- In any program, press Home button on remote control or <Home key> on front frame of equipment to return to the main interface.
- EasiNote Enter flat panel writing software, see page 20-21
- EasiFinder Enter android system resource browser, see page 21
- Browser Enter internet page, see page 22
- PIP Enter picture-in-picture image, see page 23
- EasiSetting Enter setting menu page, see page 24
- Apps Enter Android system application management page, see page 25

EasiNote



-  Menu icon Click to pop up sub-menu (change background/save)
-  Exit icon Click to exit Whiteboard software
-  Picture in picture icon Click to pop up picture in picture interface, see page 23

- | | | |
|---|-------------------|--|
|  | Image import icon | Click to import required image from memory card |
|  | Select icon | Click to select Whiteboard writing symbols, can click or check to select |
|  | Brush icon | Click to write, press long for three seconds to enter setting screen, to set brush color and thickness |
|  | Eraser icon | Click to erase writing symbols, can be erased by box selection |
|  | Cancel icon | Click to cancel previous step operation |
|  | Restore icon | Click to restore cancelled operation |
|  | Page icon | Display writing page number displayed by current picture |
|  | Add page icon | Click to add a new page of writing image |

EasiFinder

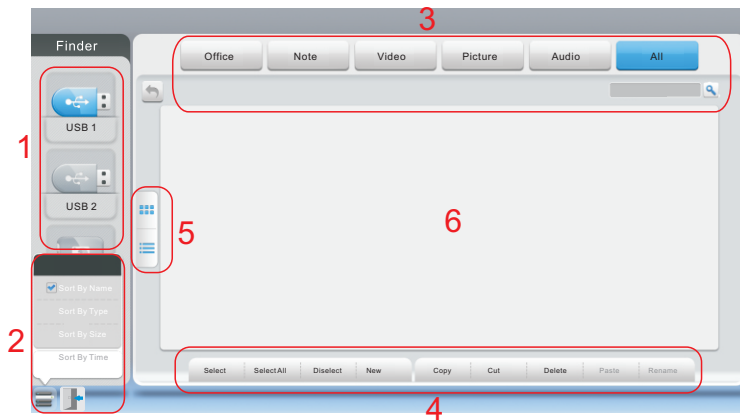

- Display files in Android system memory and Android system external storage.
 - 1, Storage device display Click with touching pen to enter corresponding storage devices area
 - 2, Menu/exit menu Click menu icon with touch pen to pop up menu options {order (type/size/time)}
Click exit icon with touch pen to directly exit resource browse.
 - 3, File type menu Documents: OFFICE type files
Blackboard writing: images stored by Whiteboard and images stored by annotation screenshots
Video: audio and video type files
Image: image type files
Music: audio type files
All: files of all types
 - 4, File operation menu Can perform basic operations towards file such as select/delete/create/copy/cut
 - 5, File arrangement menu Divided into two arrangement modes by icon and by list
 - 6, Main display area Display files of corresponding type in memory card

Browser

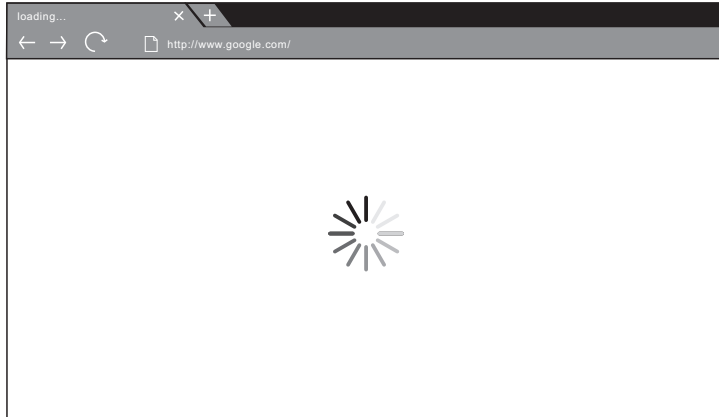

- In connected network state, enter web browsing for surfing the internet, click on "X" symbol in the upper left corner to close it

PIP

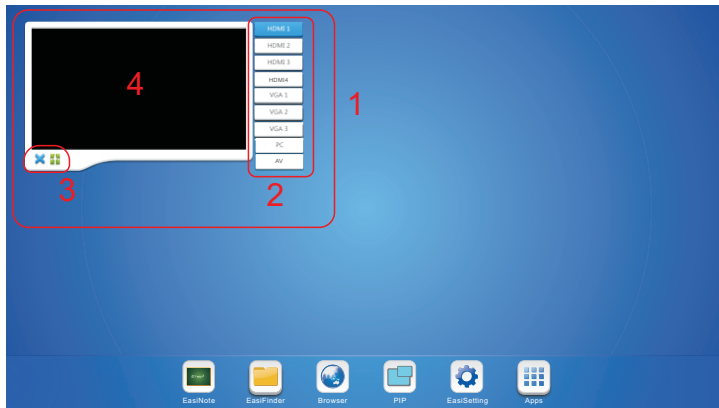

- Enter channel browse to pop up picture-in-picture interface in displayed image (as shown in Figure 1)
- Press▲ button on remote control or directly click picture-in-picture display interface point "4" with touching pen, to pop up channel selection list of picture-in-picture (as shown in the above figure "2"), press▶ button on remote control to move selection cursor into channel list, then press▼/▲ button to select corresponding channels. When selection cursor reaches the channel you need, press Enter key to play image and sound of related channel on interface "4", or directly click the channel you need to enter with touch pen.
- Picture-in-picture interface operation key is shown in above figure "3".

 Click picture-in-picture channel for full screen

 Click to exit picture-in-picture interface

Easisetting

- Shortcut Setting is setting menu, see page 13-15

Apps

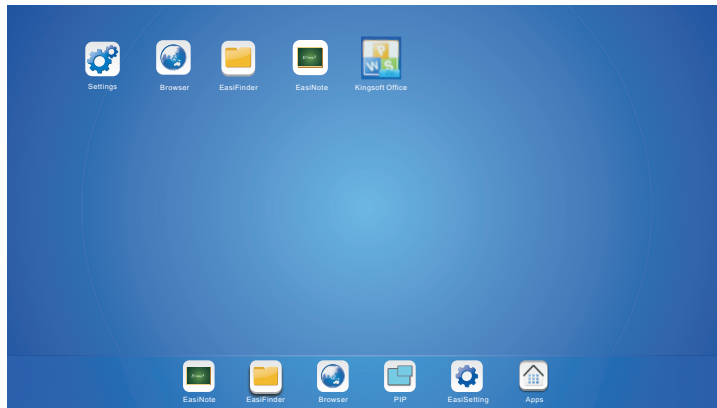

Settings	See page 15
Browser	See page 22
EasiFinder	See page 21
EasiNote	See page 20-21
Kingsoft Office	Office application software

Three Multimedia File Playback Interface

Image play

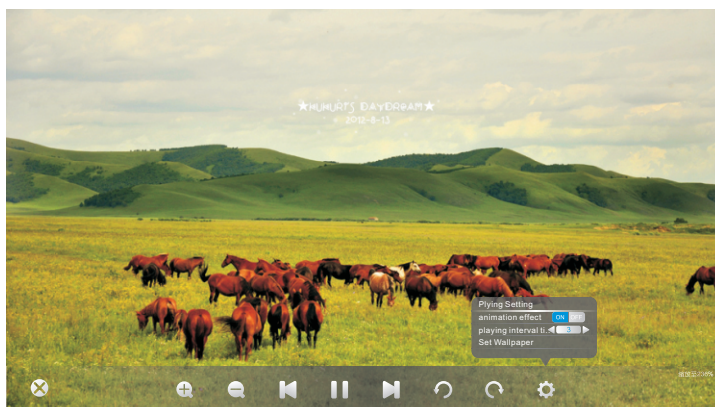

- ⊗ Close current picture played
- ⊕ Magnify current picture played
- ⊖ Reduce current picture played
- ⏮ Play previous picture
- ⏸ Play/pause
- ⏭ Play next picture
- ↺ Counterclockwise rotate current picture played
- ↻ Clockwise rotate current picture played
- ⚙ Play setting {Animation effect (on/off)/Slide time interval/Set as wallpaper}

Audio play

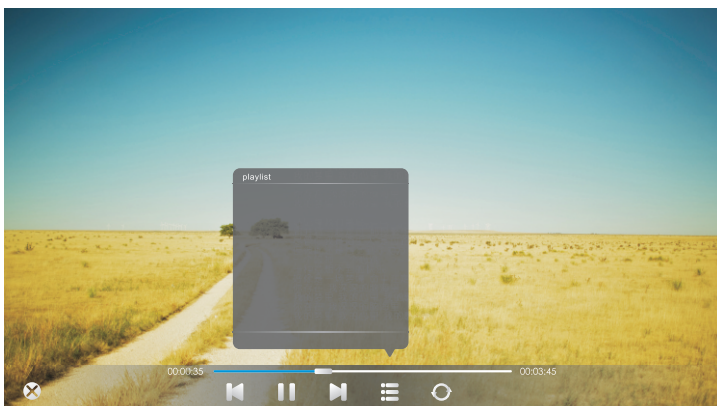

- ⊗ Close current audio file played
- ⏮ Play previous audio file
- ⏸ Play/pause
- ⏭ Play next audio file
- ☰ Playlist
- ⏪ Loop play
- 🔄 Random play
- ⏩ Single play

Video play



- ⊗ Close current video file played
- ⏮ Play previous video file
- ⏪ Fast backward
- ⏸ Play/pause
- ⏭ Fast Forward
- ⏭ Play next audio file
- ☰ Playlist

Simple troubleshooting

Machine fails to work normally

Remote control failure	<ol style="list-style-type: none"> 1. Check whether there are other objects between remote control and television remote control receiving window, thus leading to failure of remote control. 2. Check whether the battery electrode in the remote control is correct. 3. Check whether remote control needs to replace battery.
Machine automatically shut down	<ol style="list-style-type: none"> 1. Whether set sleep or not. 2. Check whether there is sudden power outage. 3. Check whether there is no signal automatic shutdown.

PC mode

Signal out of range	<ol style="list-style-type: none"> 1. Check whether display is set correctly. 2. Check whether resolution is the best resolution. 3. Adjust line and field synchronization in menu.
Background has vertical lines or streaks	<ol style="list-style-type: none"> 1. Select automatic correction in menu. 2. Adjust clock and phase position in menu.
Image lack of color, color is incorrect	<ol style="list-style-type: none"> 1. Check whether VGA is not well connected or has quality problem. 2. Adjust chromaticity and brightness or contrast in menu.
Display format that is not supported	<ol style="list-style-type: none"> 1. Select automatic correction in menu. 2. Adjust clock and phase position in menu.

Touch Function

Touch function invalid	<ol style="list-style-type: none"> 1. Check whether touch driver is installed and started. 2. Check whether the size of article touched is comparable with finger.
Touch positioning not correct	<ol style="list-style-type: none"> 1. Check whether driver is properly installed and make correction. 2. Check whether touch pen is facing the screen.

Video function can't work normally

No picture and no sound	<ol style="list-style-type: none"> 1. Check whether the machine is started state. 2. Check whether signal wire is well plugged, whether INPUT is corresponding to it. 3. If in internal computer mode, check whether internal computer is started.
With horizontal or vertical stripes or image dithering	<ol style="list-style-type: none"> 1. Check whether signal wire is well connected. 2. Check whether other electronic equipment or power tools are placed around the machine.
No color, color is weak or image is weak	<ol style="list-style-type: none"> 1. Adjust chromaticity and brightness or contrast in menu. 2. Check whether signal wire is well connected.

Audio function can't work normally

With image but without sound	<ol style="list-style-type: none"> 1. Check whether mute button is pressed for mute. 2. Press VOL. + / - to adjust volume. 3. Check whether audio line is connected correctly.
Only one speaker has sound	<ol style="list-style-type: none"> 1. Adjust sound balance in menu. 2. Check whether computer sound control panel only sets up one sound channel. 3. Check whether audio line is connected correctly.
VGA output without sound	<ol style="list-style-type: none"> 1. Check whether connect external device with headphone cable.

Maintenance

Proper maintenance can avoid many early faults; regular careful cleaning can make machine brand new; please unplug power plug before cleaning and maintenance, to prevent electric shock

Clean screen

Please mix and stir even a little fabric softener or tableware detergent with warm water.

Please use a soft cloth to be completely soaked in the mixture.

Please take out cloth and twist to half dry state to wipe machine screen.

Repeat for several times, pay attention not to squeeze water flow into machine when wiping machine.

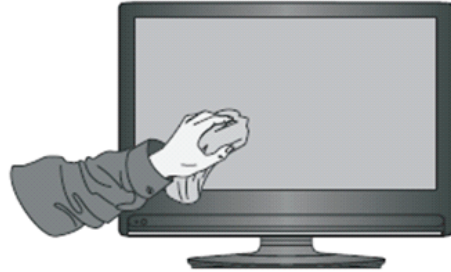

Clean face frame

Please use dry, soft, lint-free cloth to wipe front frame

No use of machine for a long time

In case of no use of machine for a long time, such as holiday, please make sure to unplug the plug to prevent any possible dangers caused by power supply ripple from lightning.

Display mode

1.VGA Mode

Resolution / Display mode	Field frequency (Hz)
640*480	60
800*600	
1024*768	60
1280*800	
1920*1080	50
	60

2.HDMI Mode

Resolution / Display mode	Field frequency (Hz)
480P	60
480i	
576P	50
576i	
720P	50
	60
1080i	50
	60
1080P	50
	60